

INSTRUCTION MANUAL

# DOOR / WINDOW SENSOR

— FIBARO SYSTEM —



## Technical support

Should you need any assistance in connecting or configuring your Home Center, please use our guides and technical presentations which can be found on our website:

**<http://www.fibaro.com/en/support>**

## Functional features



Reed sensor



Temperature sensor  
(extra option)



Binary input



Scenes switch

# Download FIBARO app for smartphone



## Start the device

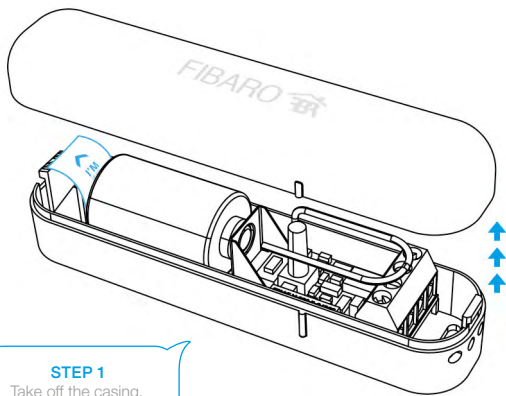

### STEP 1

Take off the casing.

## Start the device

### STEP 2

Remove the battery blocker  
"I'm ready".

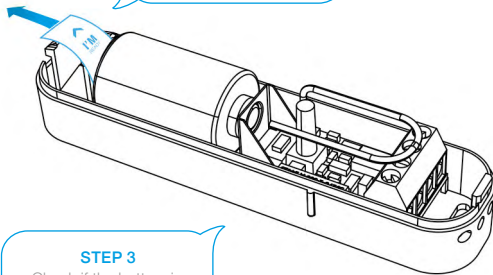

### STEP 3

Check if the battery is  
placed correctly.

## Start the device

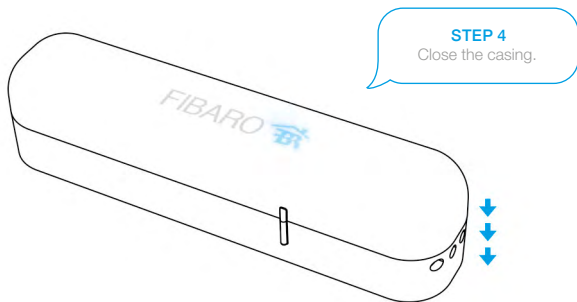

## Temperature measurement

You can get some extra functions by adding a temperature sensor\*, however it should be installed before inclusion.

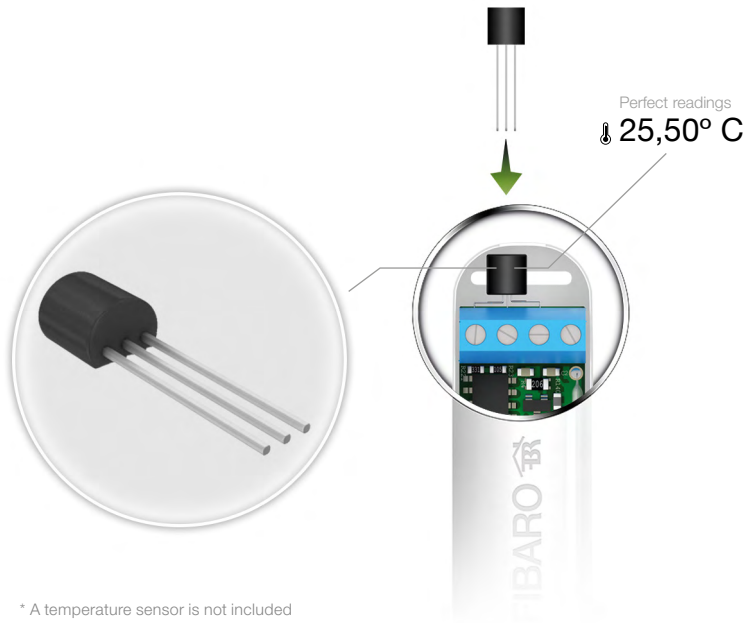

\* A temperature sensor is not included in the Door / Window Sensor set.



## Your Door / Window Sensor is ready to be added to the Home Center.

Door / Window Sensor must be in range of the Home Center because it requires a direct communication with the controller.



## Start inclusion mode

### STEP 5

Start your FIBARO application.  
Go to Settings.



## Start inclusion mode

**STEP 6**

Press "add device".



**STEP 7**

Press "Next".

## Inclusion mode has been launched

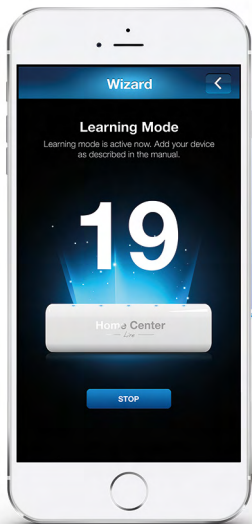

## Add your device

### STEP 8

Quickly, triple click the button in order to add your device to the system.

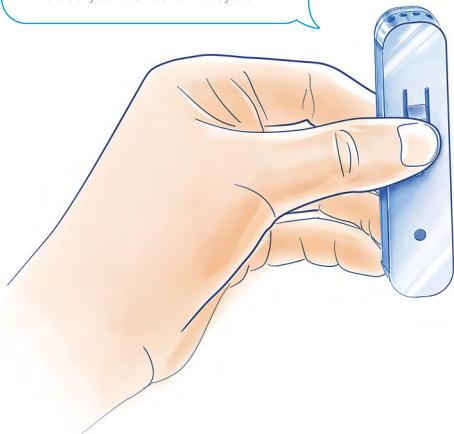

## Processing your configurations

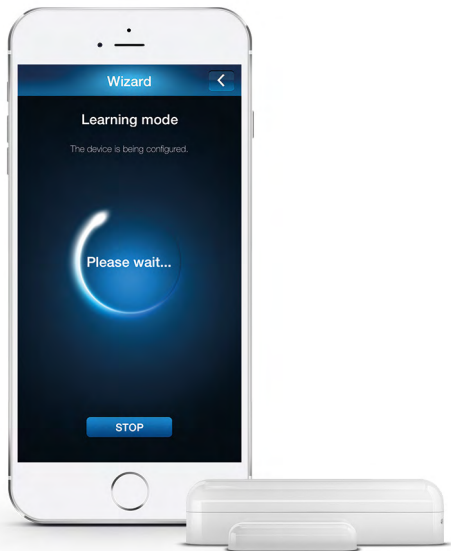

## Wake up the device



Sometimes waking up the device is not required so it will be omitted automatically.



### STEP 9

Quickly, triple click the button in order to wake up the device.

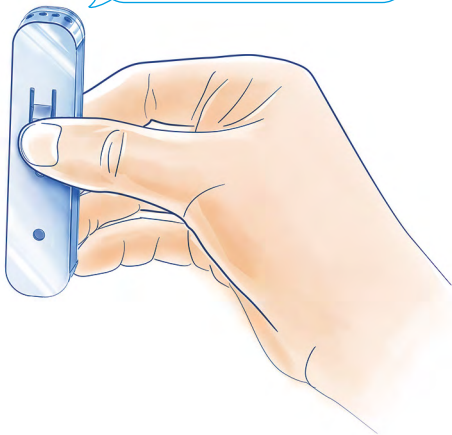

## The device has been added



### STEP 10

Name the device and assign it to the room.



## Installation

### STEP 11

Put a double-sided tape on the device and magnet.

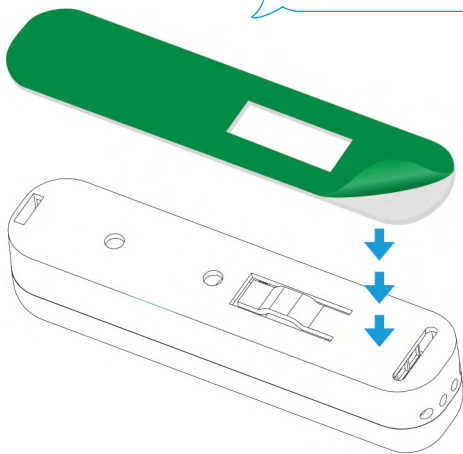

## Installation

During the installation it is recommended to wake up the device.



Make sure the sensor is in range of the Home Center because it requires a direct communication with the controller.

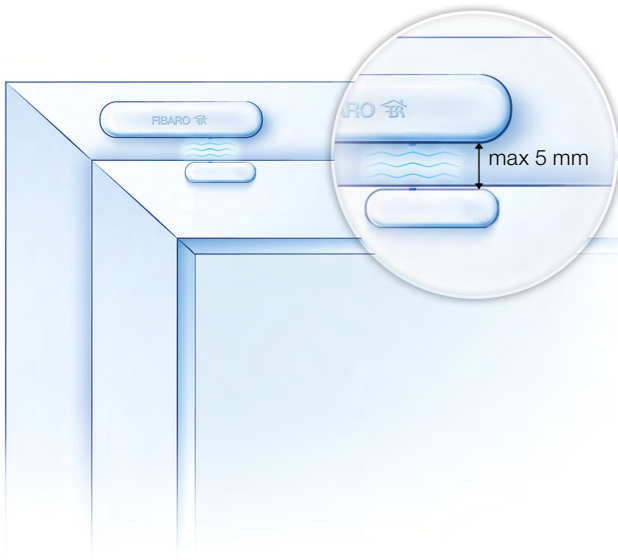

## Customized colours

Door / Window Sensor is available in seven colours  
to match any interior design.





[www.fibaro.com](http://www.fibaro.com)